



BMZ Display DS103

ORIGINAL OPERATING INSTRUCTIONS



tweewielers
méér dan fietsen!

www.pottweewielers.nl

053 572 21 98

Blankenburg 9

7481DX

Haaksbergen

IDENTIFICATION

PRODUCT

Name: BMZ Display DS103

Model: DS103

BMZ Art. No. 41385

Country of Origin: China

Mark: CE

MANUFACTURER

Zhejiang Topology Intelligent Technology Co., Ltd.

Room 702, Tower A,

DIC-innovation center, No.1190,

Bin'an Road, Binjiang District, Hangzhou City

Tel: +86 (0) 571-8763 2183

URL: www.topology-tech.com

Zip code : 310051

CUSTOMER SERVICE

www.bmz-central-service.com

DOCUMENT

Original Operating Instructions BMZ Display DS103

Version: 1.3

Date: 8/21/2019

Subject to change.

CONTENT

1	Important notes on the operating instructions	4		
2	Safety Instructions	4		
3	Product description	4		
3.1	Main features	4		
3.2	Range of application	4		
3.3	Appearance and size	4		
3.3.1	Switch appearance and dimensions	4		
3.3.2	Display appearance and dimensions	5		
3.4	Barcode	5		
3.5	Specifications	5		
3.6	Functions	5		
3.7	User Interface	6		
4	Installation	6		
5	Operation	6		
5.1	Definition of buttons	6		
5.2	Turn display on/off	6		
5.3	Enter PIN	6		
5.4	Select Assist modes	7		
5.5	Select which information to be displayed	7		
5.6	Use Walk mode	7		
5.7	Turn Headlight on/off	7		
5.8	State of Charge indicator	8		
5.9	Assist power indicator	8		
6	Change settings	8		
6.1	Introduction	8		
6.2	Change Back color	8		
6.3	Set km or miles	9		
6.4	set display brightness	9		
6.5	Set clock	9		
6.6	Turn on or off PIN query	9		
6.7	Change PIN	9		
6.8	View battery info	9		
6.9	View system info	10		
6.10	Reset to factory settings	10		
7	Clear trip data	10		
8	Troubleshooting	10		
9	Disposal	13		
10	Note	13		

1 IMPORTANT NOTES ON THE OPERATING INSTRUCTIONS

⚠ WARNING

Read these instructions carefully before using the display.

Failure to follow safety instructions and instructions may result in electric shock, fire and/or serious injury.

The instructions enable the end user safe and error-free operation of the display.

Keep this manual available to all users for future reference.

2 SAFETY INSTRUCTIONS

⚠ WARNING

Change display settings only when vehicle is standing.

Distracted riding endangers yourself and other road users.

- Do not be distracted by the display. Focus on the traffic to avoid accidents. While riding, only check the displayed elements, change the support level, or turn the lights on or off.
- To change the settings, stop and enter the appropriate data.
- Do not open the display, it could be damaged. Unauthorized opening voids the warranty.
- Do not use the display as a handle. Lifting the bicycle by the display may damage it.
- Do not place the bicycle upside down on the handlebars. The display may be damaged. Use a suitable mounting stand for repairs.
- Do not tamper with or modify the display and its associated parts.



Before starting your first ride, familiarize yourself with the functions of the power-assisted bicycle and the operation of the display.

3 PRODUCT DESCRIPTION

3.1 MAIN FEATURES

- high brightness, high contrast 3.5-inch colored TFT screen
- waterproof (IP65)
- CAN communication port

3.2 RANGE OF APPLICATION

Suitable for power-assisted bicycles in accordance with EN15194 standard.

3.3 APPEARANCE AND SIZE

The product case is constructed of ABS + PC with a tempered glass display screen.



3.3.1 SWITCH APPEARANCE AND DIMENSIONS

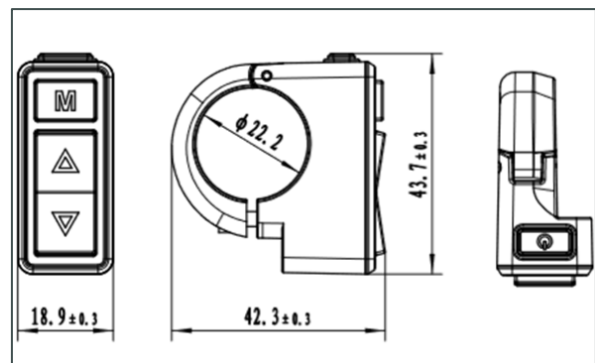

3.3.2 DISPLAY APPEARANCE AND DIMENSIONS

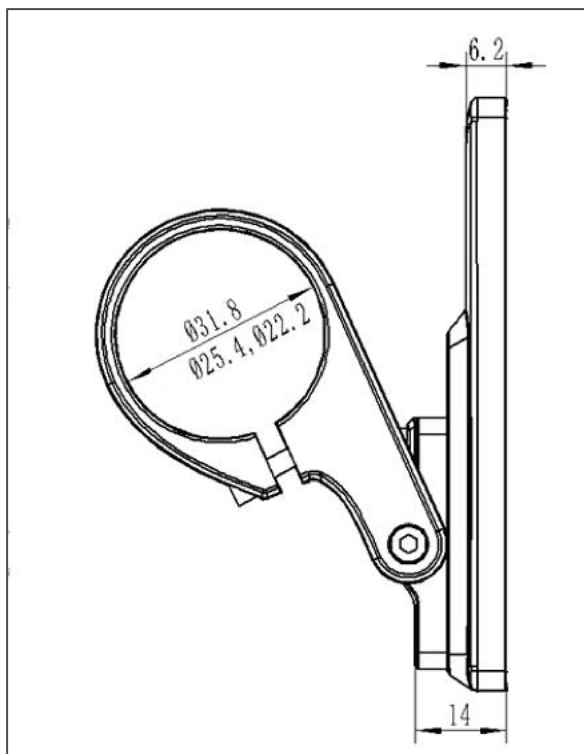
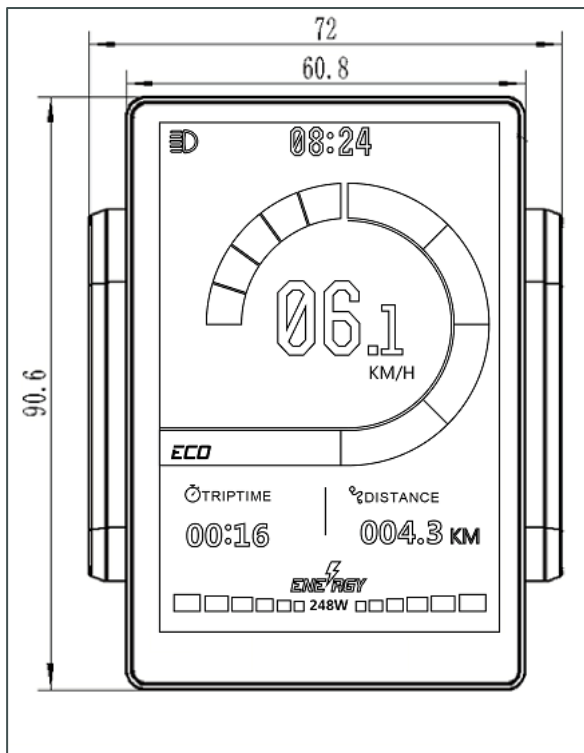

3.4 BARCODE



- DS103A: product model
- C: manufacturer code
- S2: product model code
- C01: calendar week of the production year
- B: hardware version
- 101: firmware version
- 0001: serial number

3.5 SPECIFICATIONS

- Power supply: 12 VDC
- Rated current: 5 mA / 12 V
- Screen specification: 3.5" colored TFT (320 x 480 pixels)
- Communication method: CAN
- Operating temperature: -20 °C ... 60 °C (-4 °F ... 76 °F)
- Storage temperature: -30 °C ... 80 °C (-22 °F ... 112 °F)
- Protection mark: IP65

3.6 FUNCTIONS

- Four buttons, easy to operate
- Password protected start-up
- Metric and Imperial units
- Four modes of power assistance: ECO-TOUR-SPORT-TURBO
- Walk mode (pushing aid)
- Riding time (TRIP TIME) display
- Mileage display: DISTANCE, ODO and RANGE
- E-bike system information menu
- Real-time power display (segment display, real-time numerical display)
- Adjustable brightness of backlight
- Headlight switching function
- Supports firmware upgrade, parameter setting, etc.
- Error code indicator

3.7 USER INTERFACE

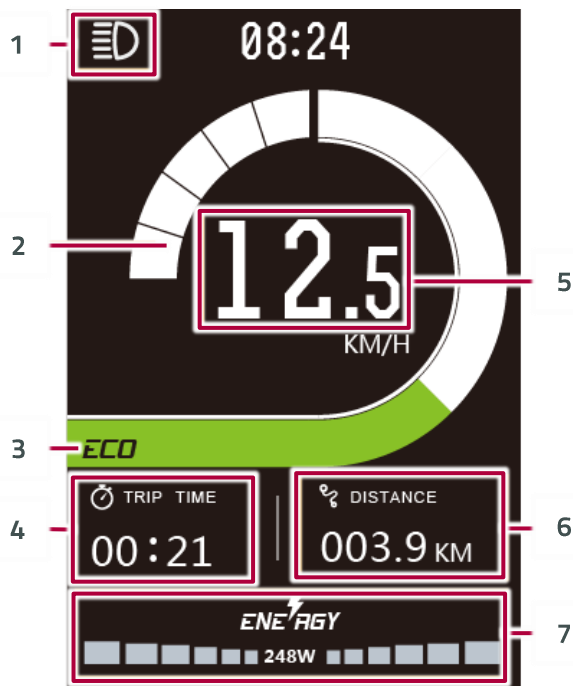

1. Headlight: icon appears when headlight is turned on
2. State of charge indicator: 5 levels indicate battery's state of charge
3. Power assistance: level of assistance
4. Trip Time: Trip time in hours and minutes
5. Speed: current speed in km/h or mph
6. Distance: Shows the trip distance
7. Energy: 6 segments show the current output of the motor

4 INSTALLATION

NOTICE

Damage caused by excessive torque is not covered by the warranty.

1. Determine if you need the optional installation clamps and rubber clip rings depending on the diameter of the handle bar (best fits handle bar dimensions: $\varnothing 22.2$ mm, $\varnothing 25.4$ mm, $\varnothing 31.8$ mm). Open the display's lock clamps and insert the rubber clips into the correct position of the lock clamps.
2. Set the rubber rings into the bracket then assemble in the middle of the handle bar. Adjust the angle of the display, to make it easy

to see when riding. After fixing the angle, tighten the screws (2.5 Allen key | 1 N m).

3. Open the lock ring of the switch and set it in the appropriate position on the left side of the handlebar. Adjust the angle of the switch, for easy operation.
4. Tighten the screw (2.5 Allen key | 0.8 N m).
5. Connect the display connector to the controller connector according to the label.

5 OPERATION

5.1 DEFINITION OF BUTTONS



1. ⏻ On/Off
2. M Menu
3. ⬆ Up
4. ⬇ Down

5.2 TURN DISPLAY ON/OFF

NOTICE

For proper operation the display, controller, and battery need to be properly connected.

To turn on the display, short-press the ⏻ button. After the battery is powered on, the display shows the user interface and is ready for operation.

To turn off, long-press the ⏻ button (appr. 2 s).

If the system is idle for 10 minutes, the display will turn off automatically.

5.3 ENTER PIN

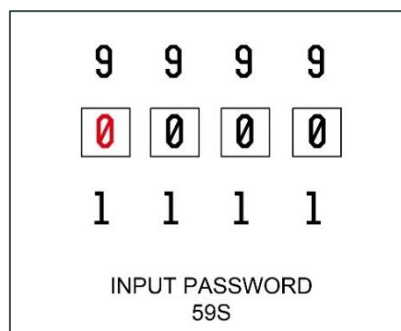

After booting up, the display prompts to enter the password.

1. Press **M** button to enter the PIN (default: 0000).
2. Use Δ/∇ to select each number; log in with **M**.
 - ⇒ The display turns to the user interface.
 - ⇒ If the PIN is incorrect, re-enter the password. The display will shut down after 60 seconds if the PIN is not entered correctly.

i To activate or deactivate the PIN query see Fehler! Verweisquelle konnte nicht gefunden werden..

To change the PIN see Fehler! Verweisquelle konnte nicht gefunden werden..

5.4 SELECT ASSIST MODES

Press Δ/∇ to change the assist mode and the output power of the motor.

Choose from these assist levels:

Assist Mode	Description	Display
OFF	Normal cycling mode - the engine is not active	
ECO	Moderate support for maximum battery range	
TOUR	Ongoing support for long distances with large battery range	
SPORT	Sporty driving on medium to short distances	
BOOST	Strong support on steep stretches or short stretches in urban traffic	

5.5 SELECT WHICH INFORMATION TO BE DISPLAYED

Press the **M** button to skip forward to the desired information:

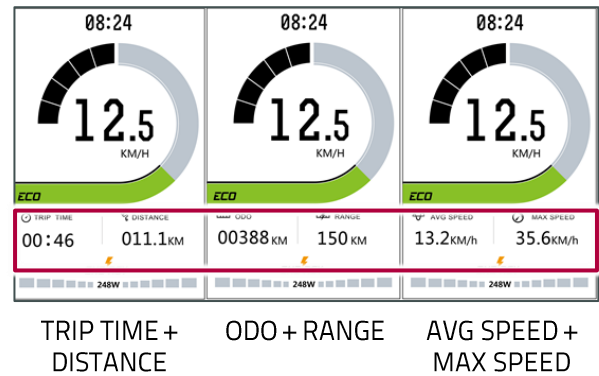

5.6 USE WALK MODE

In Walk Mode you can activate the pedelec's pushing aid.

i The pushing aid can only be used if a motor support is activated (ECO, TOUR, SPORT, TURBO). The motor assists you in pushing your pedelec at a speed of up to 6 km/h, regardless of the support level selected.

i The pushing aid serves as a support if you want to overcome a steep ramp e. g. from an underground car park or underpass. Do not use it for riding.

i The pushing aid is not a starting aid. If you operate the pushing aid under a heavy load, your engine will start jerking or even perform an emergency stop.

- To activate Walk Mode long-press the ∇ button (appr. 2 s).
 - ⇒ The **WALK** symbol appears on the display.
- Hold the ∇ button down for pushing support.
- Release the ∇ button to exit the walk mode.
 - ⇒ The previous power assist screen reappears.

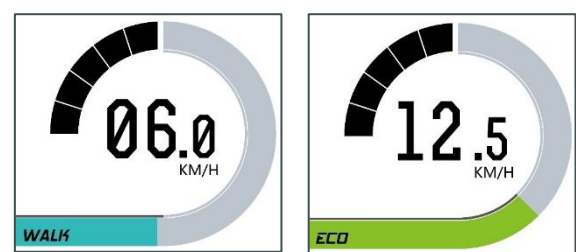

Walk mode

Normal mode

5.7 TURN HEADLIGHT ON/OFF

Long-press the Δ button (appr. 2 s) to turn the headlight on or off.

The status is indicated by the headlight icon on the display in the upper left corner.



5.8 STATE OF CHARGE INDICATOR

The battery's state of charge (SOC) is shown in 20% increments.

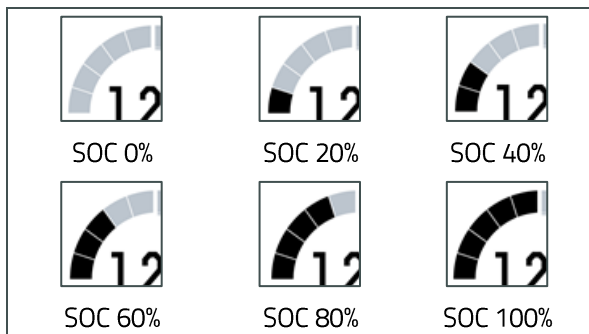

5.9 ASSIST POWER INDICATOR

During operation, the display will show the motor's current output power, ranging from level 0-6. Level 0 means no assist power.

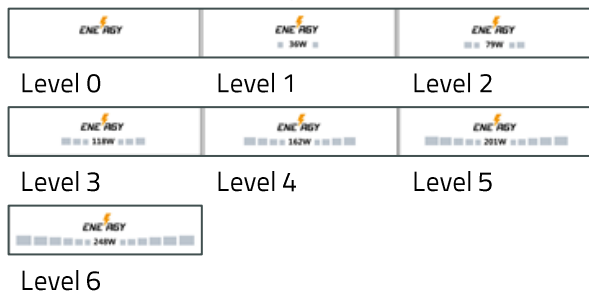

6 CHANGE SETTINGS

i Settings on your display can only be made when the bike is not in motion.

6.1 INTRODUCTION

HOW TO NAVIGATE AND SELECT

- Δ/∇ : navigate to selection.
- **M**: confirm selection.

OPEN THE SET MENU

1. Restart the display and within 10 seconds hold **M** for 2 seconds.
2. Open menu SET.
 - ⇒ To change settings, see respective subchapter.

SET		
	EXIT	
	Back Color	Black
	Unit	KMH
	Backlight	5
	Clock	>
	Set Password	>
	Battery Info	>
	System Info	>
	Reset	>

SAVE SETTINGS AND CLOSE MENU

- Hold **M** for 2 seconds.
OR
- Navigate to [EXIT] and press **M** to confirm.

6.2 CHANGE BACK COLOR

- In the BACK COLOR menu select White or Black with the Δ/∇ buttons.
- Short press the **M** button to save the selection and exit the BACK COLOR menu.
 - ⇒ The SET menu will be displayed again.

If the headlight is turned on, the display automatically converts to the black background.



6.3 SET KM OR MILES

- In the UNIT menu select [km/h] or [mph] with the Δ/∇ buttons.
- Short press the **M** button to save the selection and exit the UNIT menu.
 - ⇒ The display shows the SET menu.

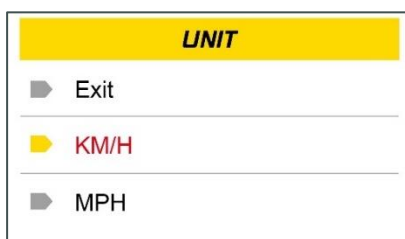

6.4 SET DISPLAY BRIGHTNESS

1. In the BACKLIGHT menu select brightness level 1 – 5 with the Δ/∇ buttons.
2. Short-press the **M** button to save the selection and exit the BACKLIGHT menu.
 - ⇒ The display shows the SET menu.

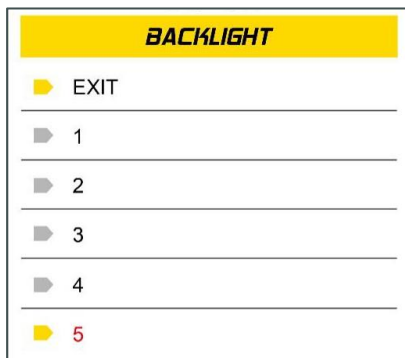

6.5 SET CLOCK

Time format: Hour:Minute

1. In the CLOCK menu change hour with Δ/∇ buttons; short-press **M** to confirm.
2. Change minutes with Δ/∇ buttons; short-press **M** to confirm.
 - ⇒ Menu SET is displayed again.

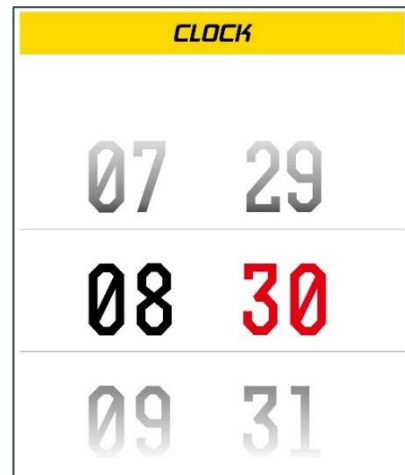

6.6 TURN ON OR OFF PIN QUERY

- In the SET PASSWORD menu navigate to [Password on Startup].
- Short-press the **M** button to set ON or OFF.

6.7 CHANGE PIN

To change the PIN [Password On Startup] must be ON.

1. In the SET PASSWORD menu select [Set Password / PIN]
2. Enter the current PIN.
3. Enter new PIN.
4. Enter new PIN again to verify.
 - ⇒ The display restarts.

If the password is not correct, the display exits to the settings menu.

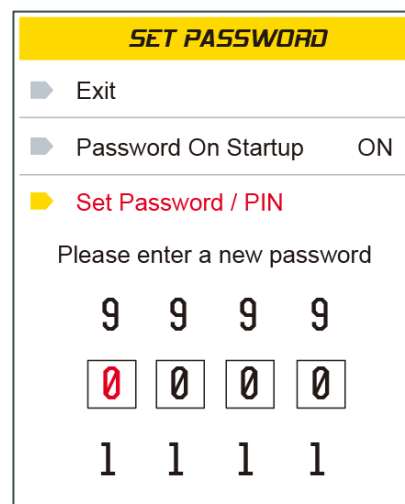

6.8 VIEW BATTERY INFO

In the BATTERY INFO menu, you can view the battery state of charge and voltage.

Short press **M** to exit to user interface.

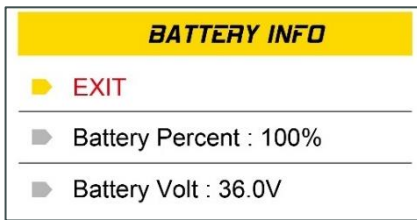

6.9 VIEW SYSTEM INFO

In the SYSTEM INFO menu, you can view the following information:

- **S/N:** Serial number of equipment
- **FW version:** Firmware version number
- **HW version:** Hardware version number
- **Motor INFO:** Motor information
- **BMS INFO:** Battery information
- **Controller INFO:** Controller information

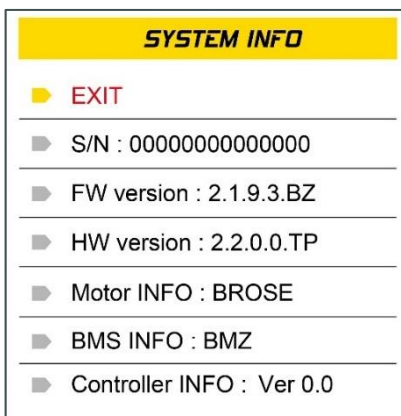

6.10 RESET TO FACTORY SETTINGS

In the RESET menu, you can reset the display to the following settings:

- Units in km
- Background color black
- Backlight level 5
- PIN query deactivated

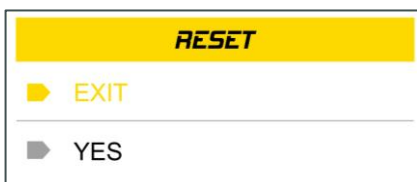

7 CLEAR TRIP DATA

INTRODUCTION

The CLEAN DATA menu allows you to clear the data of your last trip:

- Trip mileage (DISTANCE)
- riding time (TRIP TIME)
- average speed (AVG SPEED)
- maximum speed (MAX SPEED)

HOW TO NAVIGATE AND SELECT

- **Δ/∇:** navigate to selection.
- **M:** confirm selection.

INSTRUCTIONS

1. Restart the display and within 10 seconds hold **M** for 2 seconds.
2. Open CLEAN DATA menu.
3. Select [YES] to reset trip data; select [NO] to keep trip data.
⇒ The display switches to the user interface.

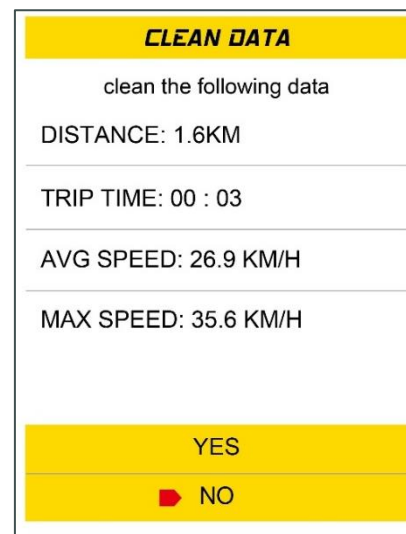

8 TROUBLESHOOTING

If an error is detected the display will show the corresponding error code.

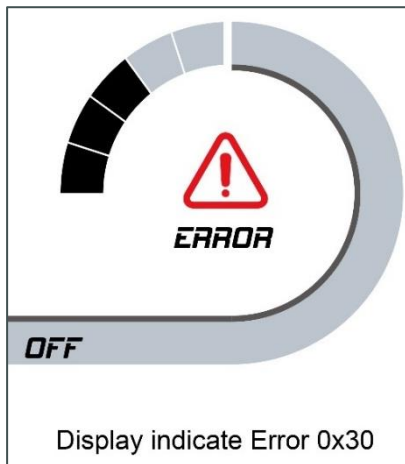

Code	Description	Recommendatoin
10	Battery under-voltage (<27 V).	Charge the battery pack using the battery charger
11	Battery over-voltage (>45 V).	Switch off the system completely. If the problem persists, contact your e-bike dealer.
12	Battery discharge detected	Charge the battery pack using the battery charger
20	ADC test failed	Switch off the system completely. If the problem persists, contact your e-bike dealer.
21	Implausible temperature from top side sensors detected	Switch off the system completely. If the problem persists, contact your e-bike dealer.
23	Implausible temperature from bottom side sensors detected	Switch off the system completely. If the problem persists, contact your e-bike dealer
24	12 V voltage drop detected (<11 V).	Charge the battery pack using the battery charger
25	motor overcurrent (>24 A).	Switch off the system completely. If the problem persists, contact your e-bike dealer

Code	Description	Recommendatoin
26	More than two unknown system resets detected	Switch off the system completely. If the problem persists, contact your e-bike dealer.
30	Communication Error	Switch off the system completely. If the problem persists, contact your e-bike dealer.
31	Low Light output voltage or dropout detected.	Check the cables and plug connections of all components of the e-bike system.
40	Measured current oversteps the mark of max. allowed current value defined in software (20 A).	Reduce the load on the motor by pedaling less or by reducing the assist level.
41	Hardware over current protection active.	Reduce the load on the motor by pedaling less or by reducing the assist level.
42	Angel sensor error detected.	Switch off the system completely. If the problem persists, contact your e-bike dealer.
43	Measured current after motor support does not fall below max. allowed current value defined in software (2A).	Switch off the system completely. If the problem persists, contact your e-bike dealer.
44	Temperature oversteps the mark of max. allowed temperature value defined with parameter	Reduce the load on the motor by pedaling less or by reducing the assist level.
45	Angle sensor reset detected	Switch off the system completely. If the problem persists, contact your e-bike dealer.

Code	Description	Recommendatoin
46	No motor movement although measuring a current >2 A.	Switch off the system completely. If the problem persists, contact your e-bike dealer.
60	HMI CAN message timeout detected.	Check the cables and plug connections of all components of the e-bike system.
70	Measured torque sensor value exceeds range defined in software ([230Hz..450Hz])	Switch off the system completely. If the problem persists, contact your e-bike dealer.
71	Cadence sens short circuit	Switch off the system completely. If the problem persists, contact your e-bike dealer.
72	Not receiving any signals from torque sensor.	Switch off the system completely. If the problem persists, contact your e-bike dealer.
73	Measured Torque difference between two measurements oversteps the mark of max. allowed torque difference value defined in software (+/-166).	Switch off the system completely. If the problem persists, contact your e-bike dealer.
74	RAM test failed.	Switch off the system completely. If the problem persists, contact your e-bike dealer.
75	Invalid treadle sensor signal detected.	Switch off the system completely. If the problem persists, contact your e-bike dealer.
76	12 V out overcurrent	Switch off the system completely. If the problem persists, contact your e-bike dealer.

Code	Description	Recommendatoin
80	No offset angle calibration performed (EOL).	Switch off the system completely. If the problem persists, contact your e-bike dealer.
81	No Interrupts from speed sensor detected.	Switch off the system completely. If the problem persists, contact your e-bike dealer.
82	ROM test failed.	Switch off the system completely. If the problem persists, contact your e-bike dealer.
83	Stack test failed.	Switch off the system completely. If the problem persists, contact your e-bike dealer.
84	No serial number detected.	Switch off the system completely. If the problem persists, contact your e-bike dealer.
85	Throttle switch CAN message timeout detected.	Check the cables and plug connections of all components of the e-bike system.
86	Measured accelerator throttle voltage exceeds range defined in software (0,5 V...4,2 V).	Switch off the system completely. If the problem persists, contact your e-bike dealer.
87	Accelerator Throttle has not been in off-position yet (zero torque request) (~0,5V)	Switch off the system completely. If the problem persists, contact your e-bike dealer.
90	Program flow error detected	Switch off the system completely. If the problem persists, contact your e-bike dealer.
91 92 93	Torque Sensor sent erroneous data.	Switch off the system completely. If the problem persists, contact your e-bike dealer.

Code	Description	Recommendation
94	High side driver detected an error (over current or temperature).	Switch off the system completely. If the problem persists, contact your e-bike dealer.
95	Brake light current >0,3 A detected	Check the cables and plug connections of all components of the e-bike system.

i After troubleshooting, the display will automatically switch to the normal user interface.

9 DISPOSAL



Do not throw electrical appliances and batteries into the household waste.



In accordance with the European Directive 2012/19/EU, electrical appliances which are no longer serviceable must be collected separately, and in accordance with the European Directive 2006/66/EC. Defective or used batteries must be

collected separately and recycled in an environmentally friendly manner.

Electronic devices, replacement parts and packaging are made of recyclable materials. The owner is obliged to dispose of these properly and in an environmentally friendly manner in accordance with the statutory regulations.

All plastic injection molded parts are marked with a recycling symbol. RoHS Directive (2011/65/EU).

10 NOTE

- When using the display, pay attention to safety; do not plug the display in and out when the power is on.
- Try to avoid using exposure in harsh environments like heavy rain, heavy snow, and strong sunlight.
- When the display cannot be used normally, it should be sent to repair as soon as possible.

**BMZ GmbH**

Am Sportplatz 28
63791 Karlstein am Main
Germany

Phone +49 61 88-9956-0
Fax +49 61 88-9956-900
kontakt@bmz-group.com

Web

www.bmz-group.com

Service

centralservice@bmz-group.com

BMZ Company Ltd.

2nd Building, NO.2 Jinlong Street
Baolong Industry Zone, Longgang
518116 Shenzhen

China
Phone +86 755 89775-800
Fax +86 755 89775-900
sales@bmz-group.com

BMZ USA Inc.

2656 Lishelle Place
Virginia Beach, VA 23452
USA

Phone +1 757 821-8494
Fax +1 757 821-8499
bmz-usa@bmz-group.com

BMZ Poland Sp. z o.o.

Alberta Einsteina 9
PL-44-109 Gliwice
Poland

Phone +48 32 7842-450
Fax +48 32 7842-451
biuro@bmz-group.com

BMZ France S.A.R.L.

153, Boulevard Haussmann
75008 Paris
France

Phone +33 6 84 52 76 29
jean-marc.brunet@bmz-group.com